

LED Strips

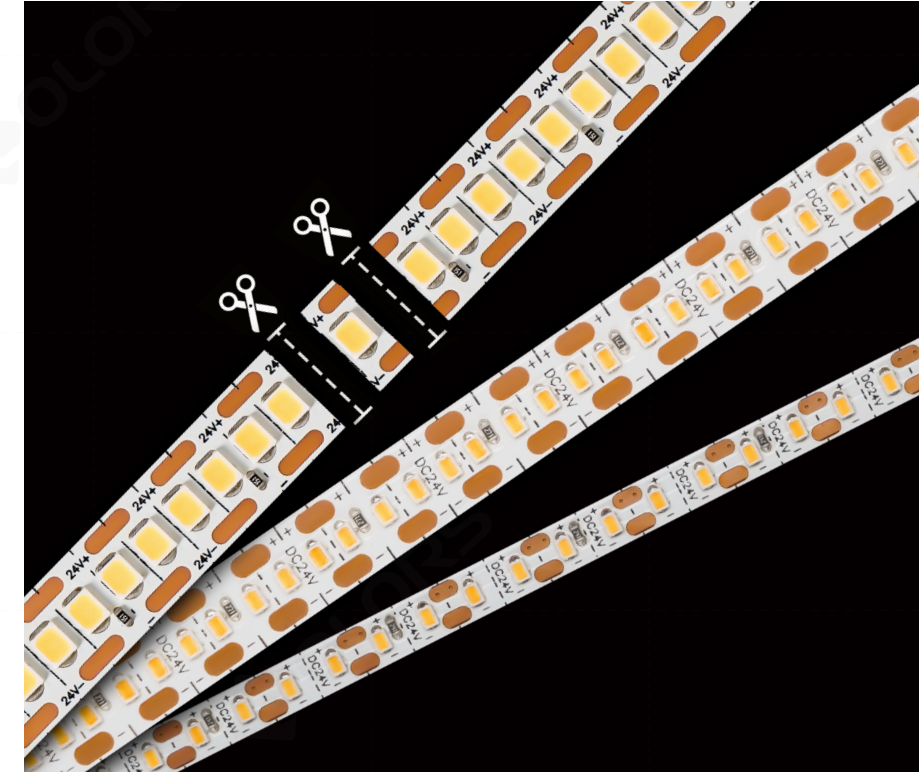

Free-cutting
· 24V 1LED/CUT
· CRI90 140LM/W

7 years



CSP · DOT
· Super durable
· -40~+60°C

5 years



CSP · Linear
· High reliability
· SDCM<3

7 years



High Efficiency
· ERP B 215LM/W
· ERP C 180LM/W
· KSF SMD2835

5 years

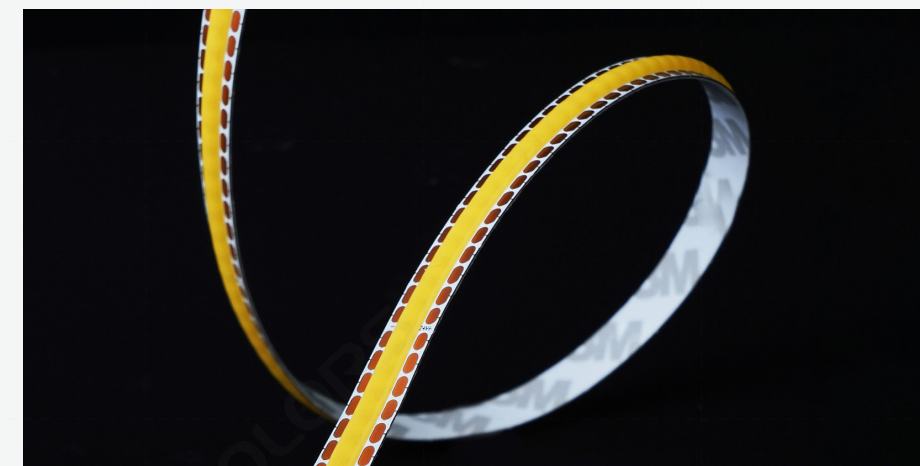

COF
· Free cutting(3.68mm)
· Free connecting

5 years

Neon Strips



Arch Neon · AF Series
· Weather fastness
· -40~+60°C, IP67

7 years

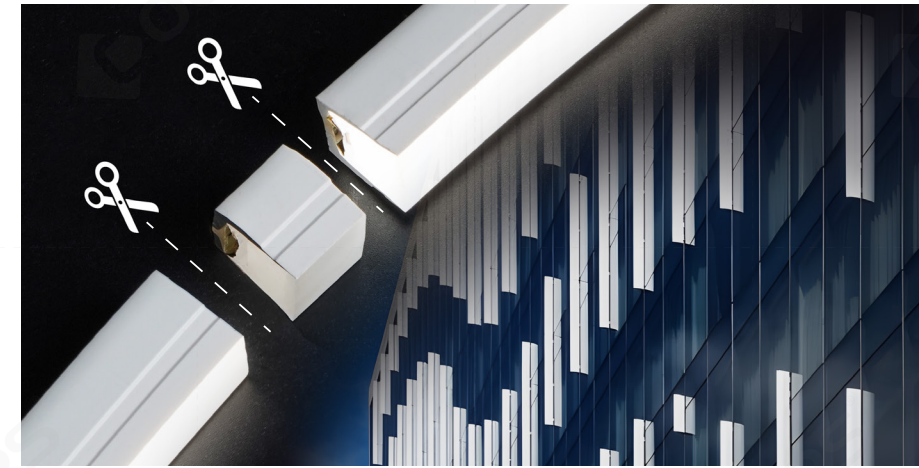

Arch Neon · AH Series
· Free-Cutting
· 110LM/W, IP67

7 years

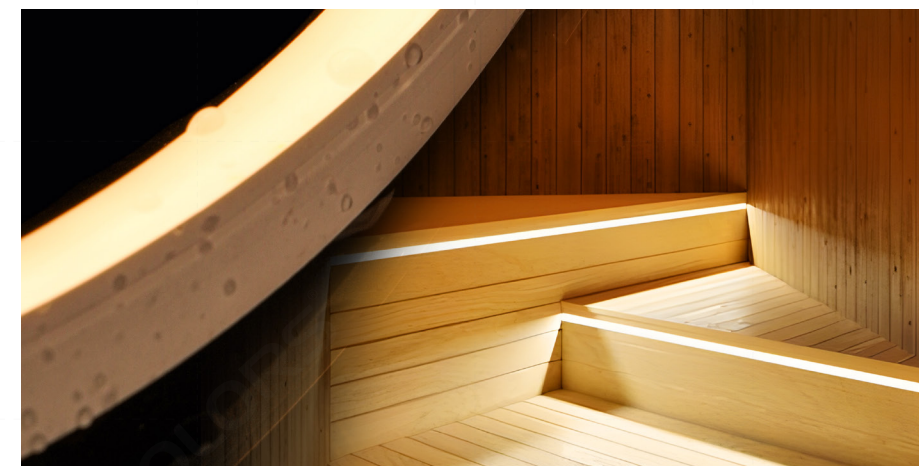

Arch Neon · AN Series
· Sauna used
· 110°C, IP67

5 years

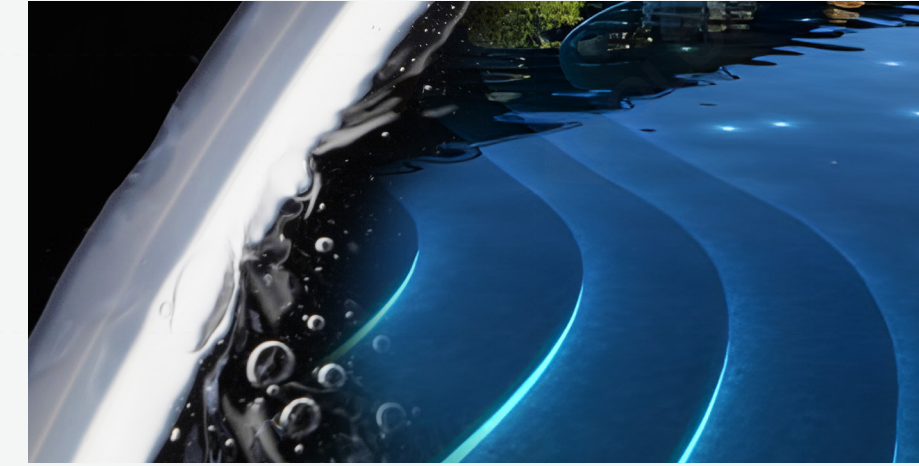

Arch Neon · AW Series
· Underwater used
· 3m deep, IP68

5 years

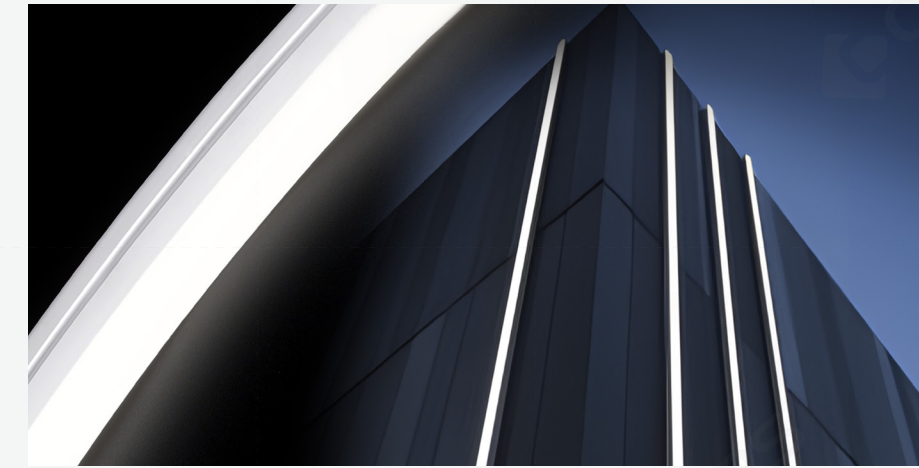

Arch Neon · AC Series
· AC 230V
· 50m, flicker-free

5 years



360 Neon · NNR40 Series
· Wearable system

5 years

COLORSLED Online Store

Make B2B Deals as simple as Amazon!



Get All Product Information

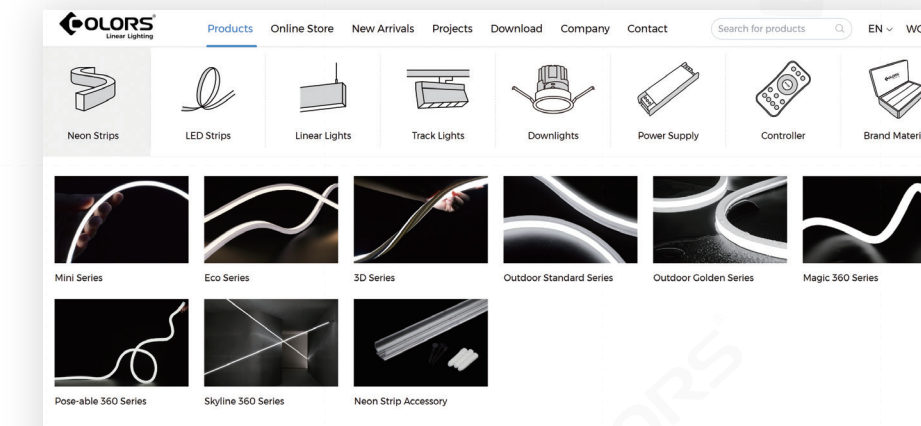

- Product Information:** Categories, Series and Details.
- New Arrivals:** Information about newly available products.
- Download:** Catalogue, Brochure, Specification, Test Report, User Manual, Patent & Certification

Instant Price Checks
Check prices and export Proforma Invoices (PI) in a flash

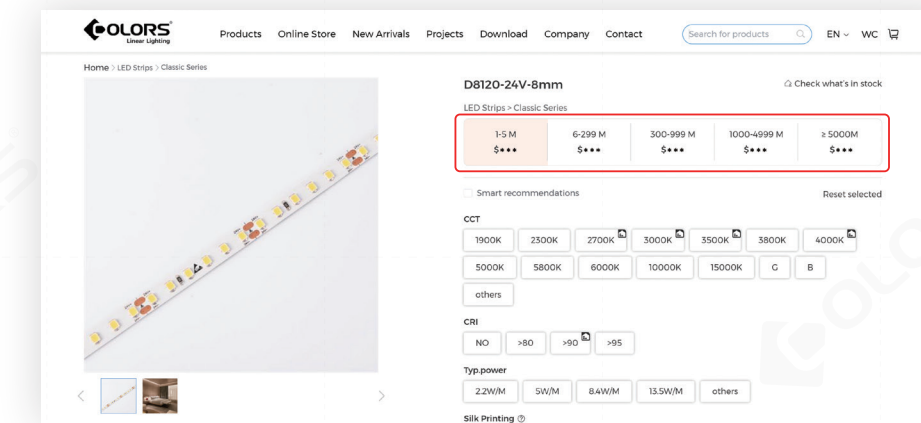

Flexible Options And Bespoke

Flexible Options: Customizable choices cater to your needs and preferences.

- Check Stock and Bulk Buy
- Inquire Lead Time
- Associated Accessories
- 3D Modeling and Render-3D-Visualization
- Bespoke

7 Days Quick Delivery

No MOQ

Place An Order And Process All At A Glance

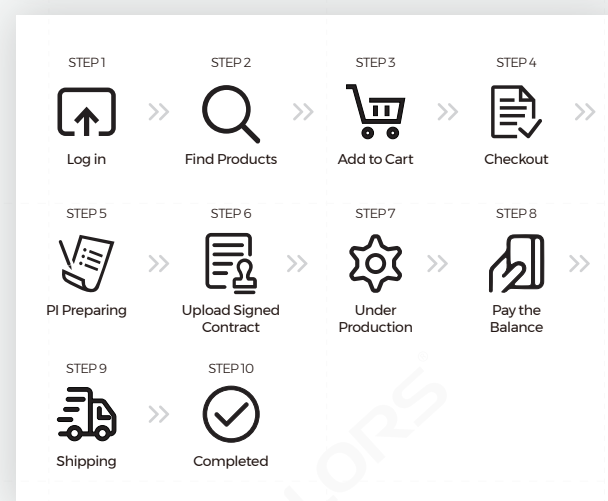
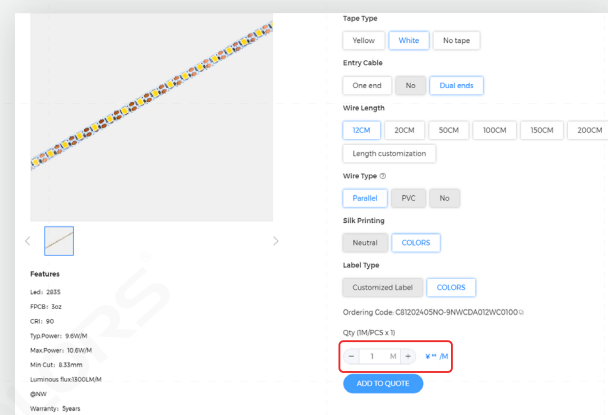
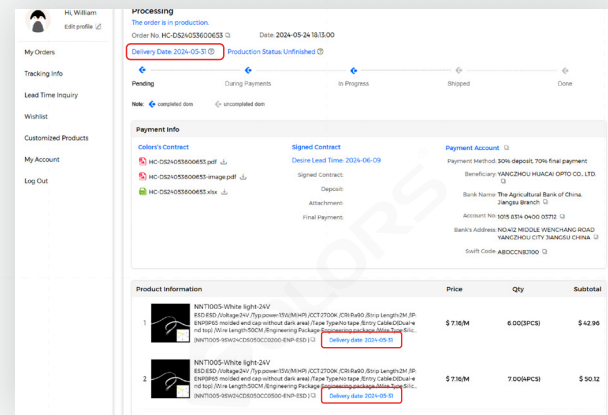
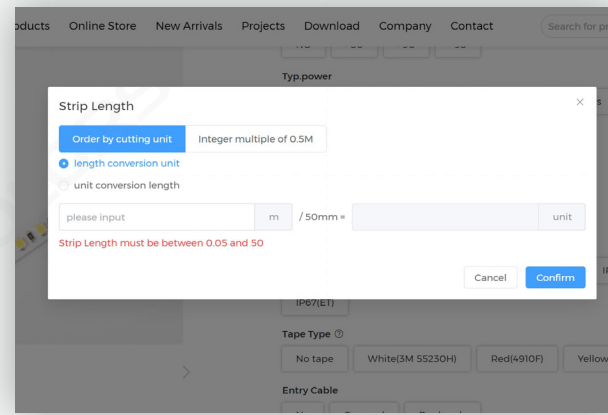

Receive Order Notifications By Email

- Delivery Date
- Production Status
- Logistics Tracking
- Change Order

2025
NEW ARRIVAL



Infinite Lights

A highly customizable lighting solution

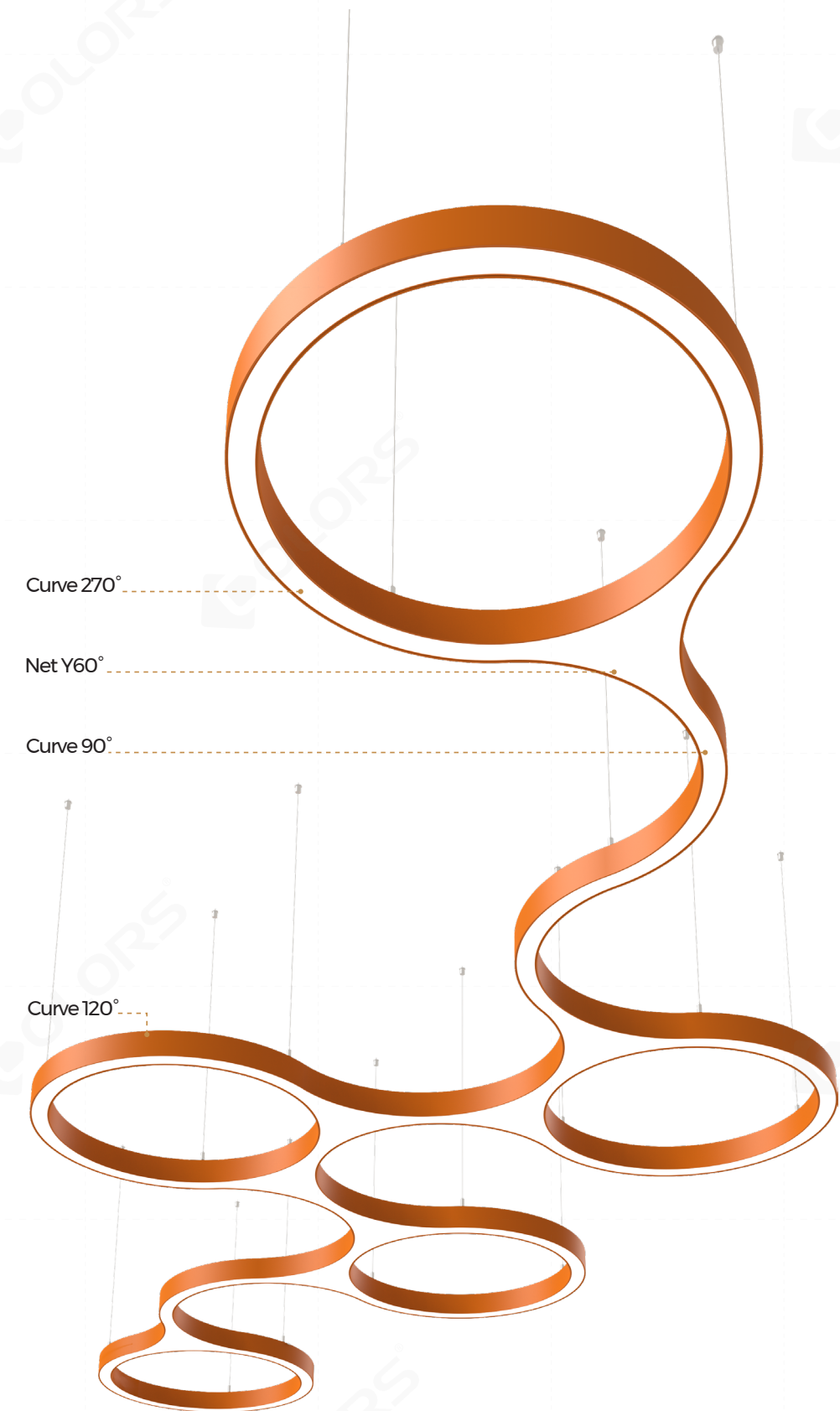

Curve 270°

Net Y60°

Curve 90°

Curve 120°

This model consists of: 2 PCS Curve 270° 3 PCS Curve 90°
8 PCS Net Y60° 6 PCS Curve 120°

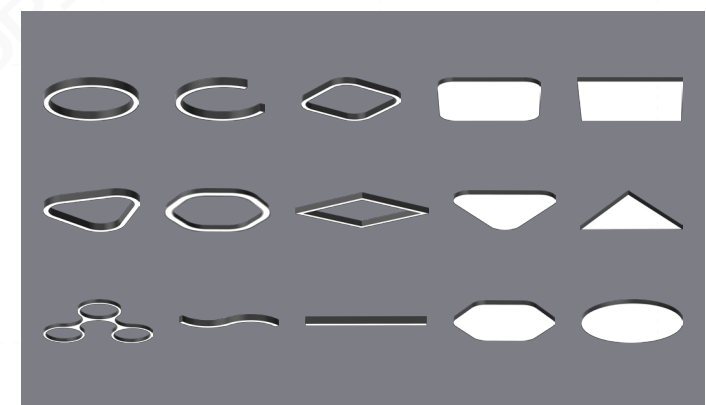

1 Ready-Made Shapes

- 1,000+ item options for linear and panel lights
- UGR ≤ 19, up to 130 LM/W
- Rich variety of mounting methods and accessory options



2 Modules

- Modular design
- Quick structural and electrical connection
- Running length: 20m

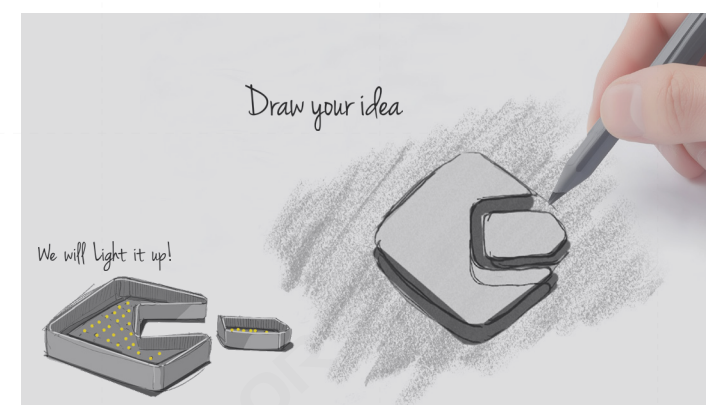

3 Customization

- Any color can be customized
- NO MOQ
- 10-day delivery

COLORS Lighting Design Platform

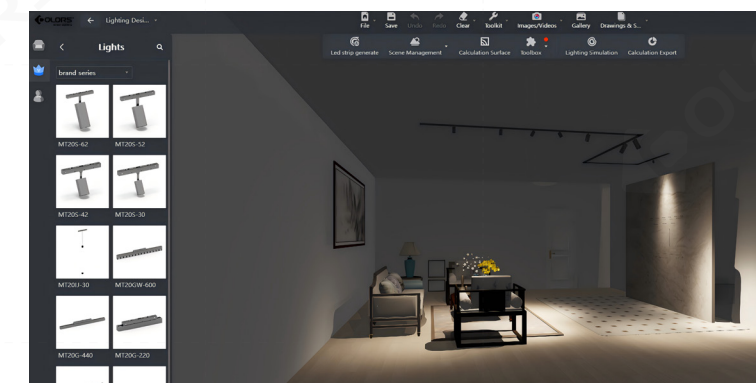

Integrate All COLORS Product-Models

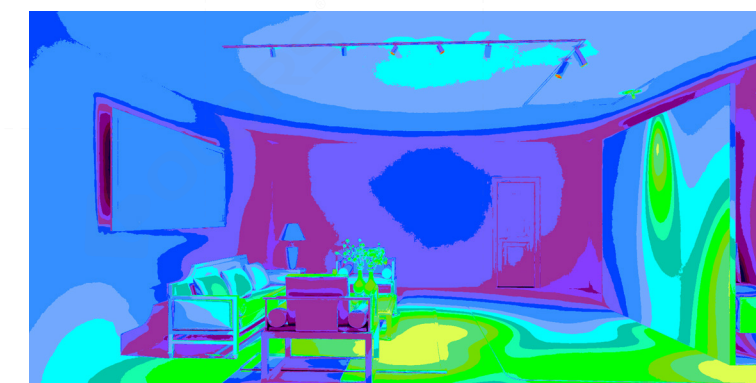

Accurate Lighting Simulation



Lighting Scene Rendering



Quick Quotation And Ordering

Linear Lights

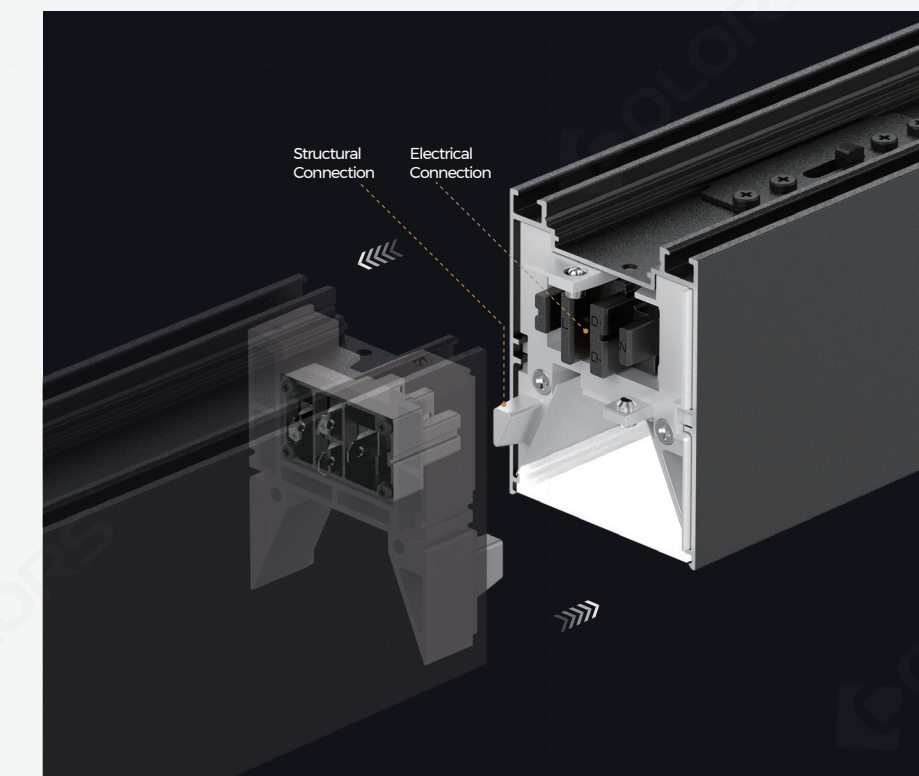

LINE ECO Series

- 1-Second-Connect
- UGR<19, 135 LM/W

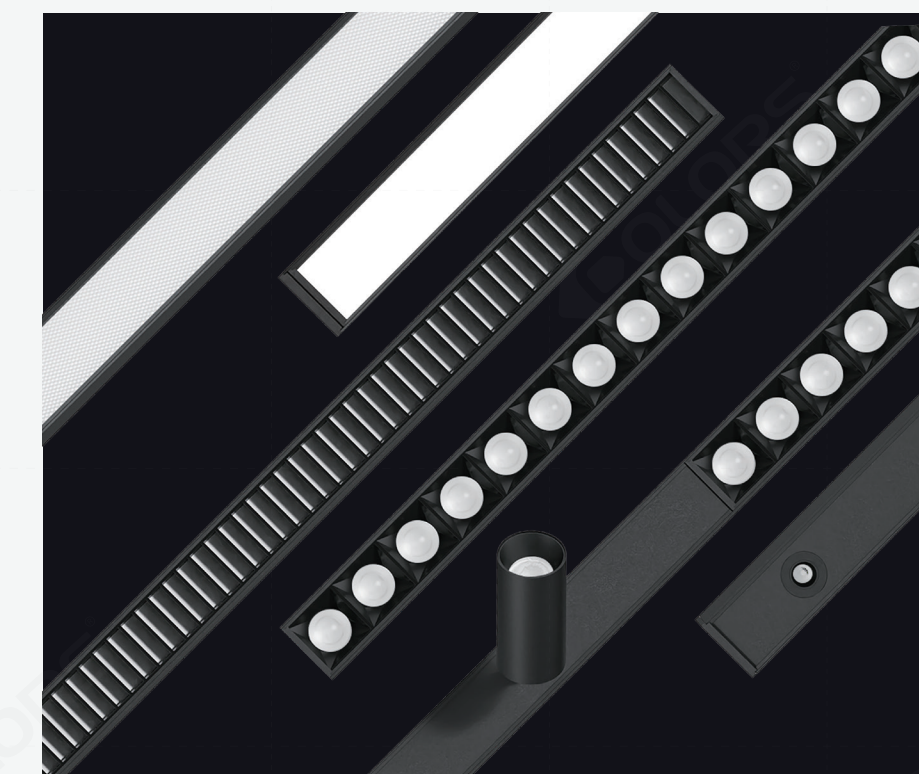

TLS-S40&TLS-S60 Series

- Modular Design
- UGR<19 145LM/W

Track Lights



MicroTrack T1 Series

- 10.2mm Ultra-thin
- 4-Wire Dimmable

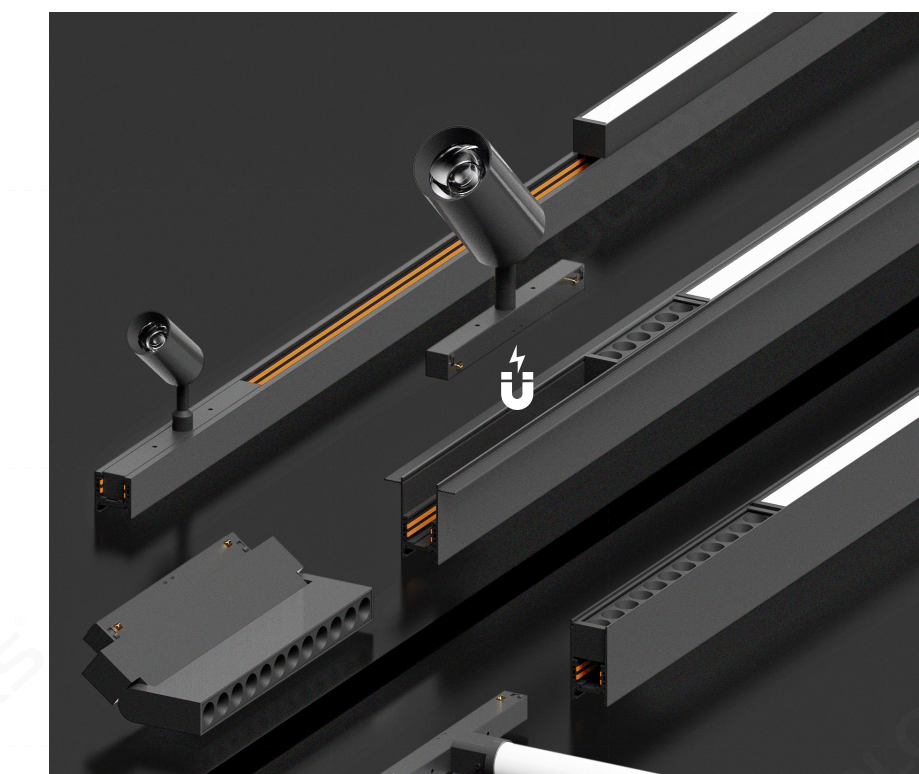

MagTrack 20 Series

- Magnetic System
- 24V-48V Compatible

Downlights



HOLA & HOLA T Series

- Plug-In Installation
- 52mm Ultra-Thin



KING Series

- Modular Design
- UGR<1, 100LM/W

ABOUT COLORS

HUACAI OPTO CO., LTD. (COLORS), founded in 2008, is a national high-tech enterprise specializing in LED lighting. It has incubated a forefront-ranked brand-COLORS in the segmented domain, proficient in providing comprehensive lighting solutions for residential, office, commercial scenarios and the like, aspiring to become a worldly-influential innovative brand.

17 Seventeen-year History

Becomes a leading enterprise enterprise in the segmented domain with 17-year accumulation.

Group Company

Headquartered in Shenzhen, and more branches layout in the Yangzhou and Jiangmen.

Production Base

2 self-established factories in Yangzhou and Jiangmen, covering an area of 45,000m². Featured in stable high-quality, strong production capacity and quick delivery.

Product System

The full product system includes led strips, neon strips, linear lights, track lights and downlights. Proficient in providing comprehensive lighting solution for residential, office, commercial scenes etc.



Tel: +86-755-2923-1888
E-mail: colors@colorsled.com
Web: www.colorsled.com

Add: 17F, Block B, Building 2, North of Skyworth Inno Valley, Shiyao town, Bao'an District, Shenzhen